

RINO
by Palazzoli

Lighting to save



excellence
FROM ITALY

Palazzoli

• Simplified installation

The fastening system with eyebolts enables the luminaire to be mounted to the ceiling without opening it. The light fixture is powered by means of a connector for quick connection to the power grid.

• Resistant and safe

The stainless steel casing and the total absence of welded joints guarantee a high resistance to corrosion and aggressive atmospheres.

• Improved visual comfort

The extra wide beam, narrow beam and comfort optics using specialist lenses with a glare index of UGR<22.

• Efficient and effective

The latest generation of LED technology ensures high luminous efficiency up to 142 lm/W.

Wide range of solutions and accessories

RINO is the new series of watertight light fixtures in **AISI 304 stainless steel** and painted galvanized steel.

They are also suitable for applications where greater resistance to environmental aggression is required.

There are 5 versions available:

- On/Off
- DALI
- Emergency 1h and 3h
- HT +55 °C

and various fastening accessories:



Pendant
(standard)



Adjustable
code 820010



Ceiling
code 820017



Pole fitting
code 820016

Environments and materials



AISI 304 stainless steel

Material characterized by a higher resistance to oxidation and corrosion. Easy to clean and with excellent hygienic coefficient.

Suitable for: cellars, poultry sheds, kitchen hoods, livestock industries, greenhouses and with redundancy in all environments where galvanized steel is required.

Painted galvanized steel

Material with a zinc coating to protect the steel from corrosion. Special care is used in the cleaning phase to avoid damaging the protective coating.

Suitable for: storage areas, cold storage rooms, garages, gymnasiums, prisons, electrical and mechanical industries.

Glass diffuser

The glass diffuser maintains the characteristics of high transparency and guarantees the uniformity of the luminous flux over time.

Polycarbonate diffuser

The UV stabilized polycarbonate diffuser meets the HACCP requirements for food environments and maintains its characteristics over time.



Custom light

EXTRA WIDE BEAM OPTICS

opening: 110°

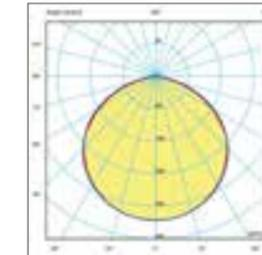

For effective illumination of the whole area.

For heights from 3 m to 5 m



Installation example:

Device code 822482 (63w - 8946lm)

(h) installation height: 3.5 m

(i) interdistance between devices in a row: 9 m

(p) span between rows: 9.5 m

COMFORT OPTICS

opening: 88°

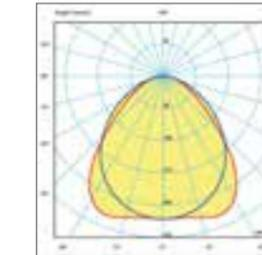

UGR < 22

It reduces glare and controls the emission in the transverse plane, restricting the emission for angles above 60°.

For heights from 5 m to 10 m



Installation example:

Device code 821482 (63w - 8631lm)

(h) installation height: 8 m

(i) interdistance between devices in a row: 9 m

(p) span between rows: 9.5 m

NARROW BEAM OPTICS

opening: 30° x 90°

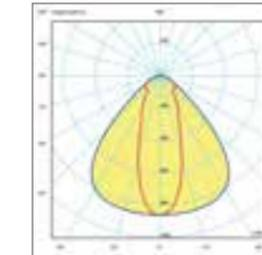

UGR < 22

It enables to have large longitudinal spans in the presence of shelving. The control of the light beams by means of the lenses makes the work environment comfortable.

For longitudinal spans with shelving



Installation example:

Device code 820482 (63w - 8001lm)

(h) installation height: 8 m

(p) span between rows: 12 m

(i) aisle width: 2.5 m

**Quality, Reliability, Durability,
Convenience, Beauty.**

Values that have always
inspired Palazzoli products.



Data sheet



Watertight LED light fixtures for use in industrial, commercial and food environments. The body is made of a single piece of AISI 304 stainless steel or galvanized steel without welded joints, able to withstand harsh environmental conditions.

The diffuser in tempered glass or UV stabilized polycarbonate is attached to the body, thanks to a system of AISI 304 stainless steel fastenings. The IP66 rating is guaranteed by a reinforced gasket in anti-ageing elastomer. The light fixture is equipped with M8 threaded eyebolts that are screwed to the body with no need to open the luminaire. They enable mounting the luminaire to chains, ropes and lighting busbars. Wiring is made with high-temperature cables with a maximum cross-section of 1.5 mm².

The luminaire are equipped with an external hermetic IP66/IP67 connector for the entry of cables with a maximum cross-section of 1.5 mm² and sheath diameter of 7 mm to 13 mm.



HT +55 °C

ON REQUEST: in addition to the codes in the brochure, it is possible to request all the light fixtures combining the materials, optics, power supplies and operating temperatures indicated in the range. Versions with feed-through wiring are also available.

The complete range of LED light fixtures for Marine and ATEX applications is available at www.palazzoli.com

The photometric curves (LDT files) are available on www.palazzolilux.com

Compliance with standards	Directive 2014/35/EU EN 60598-1 EN 60598-2-1 EN 62471 EN 60598-2-22 EN 62493 IEC/TR 62778 Directive 2014/30/EU EN 55015 EN 61547 EN 61000-3-2 EN 61000-3-3 Directive 2011/65/EU EN 50581 EN 60598-2-24
Body material	AISI 304 stainless steel Painted galvanized steel
Diffuser material	Tempered glass and UV stabilised polycarbonate
Protection rating (IP as per IEC/EN 60529)	IP66
Paint	Non-toxic polyester resistant to weather conditions and UV rays
Colour	RAL 9016 (painted galvanized steel version)
Impact resistance (IK rating as per IEC/EN 62262)	IK09
Corrosion class according to ISO 9223	C5 AISI 304 stainless steel C4 painted galvanized steel
Weight	Light fixture length 690 mm: 3.4 kg Light fixture length 1300 mm: 6.2 kg
LED device efficiency	up to 142 lm/W
Colour temperature	4000K
CRI	≥ 80
Insulation class	I
Supply voltage	220V-240V 50-60Hz
Input surge protection according to EN 61000	2 kV
Residual flicker	< 3%
Photobiological risk	Exempt
Glare index	UGR < 22
Power factor	≥ 0.95
Max. conductor cross-section	1.5 mm ²
Entry cable diameter	7-13 mm
Emergency battery lifetime	1h-3h
Emergency battery charging time	24h
Estimated device lifetime	L80 B10 @50.000h Tq=25 °C Tq= +55 °C (HT version)
Storage temperature	-40 °C - +70 °C -30°C - +45°C
Operating temperature	-30 °C - +55 °C (HT version) (Special solutions for low temperature applications available on request)

AISI 304 stainless steel



Glass

50000h | -30°C +45°C | up to 142 lm/W

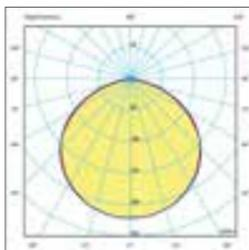

LED light fixture in **stainless steel-glass** with **extra wide beam optics 110° IP66**

Device power (W)	Length (mm)	Nominal flux (lm) Tj= 25 °C	Output flux (lm) Tq= 25 °C	Correspondence to traditional lamps (W)	Version	Palazzoli code	Pack Qty
26	690	4100	3692	2x18 - T8	on-off as standard	822182	1
40	690	6440	5640	2x36 - T8		822282	1
52	1300	8200	7384	2x58 - T8		822382	1
63	1300	11000	8946	2x80 - T5		822482	1
75	1300	12200	10575	1x150 - ME		822582	1

Equipment included: pair of eyebolts in AISI 304 stainless steel for pendant mounting, code 820011. Power supply with quick connector. Notes: the stated values may be subject to a +/- 7% tolerance.

50000h | -30°C +45°C | up to 137 lm/W | UGR < 22 | with comfort 88° lens

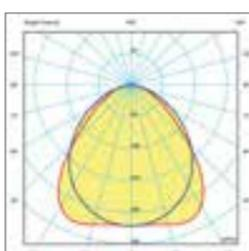

LED light fixture in **stainless steel-glass** with **comfort 88° extra wide beam optics IP66**

Device power (W)	Length (mm)	Nominal flux (lm) Tj= 25 °C	Output flux (lm) Tq= 25 °C	Correspondence to traditional lamps (W)	Version	Palazzoli code	Pack Qty
26	690	4100	3562	2x18 - T8	on-off as standard	821182	1
40	690	6440	5400	2x36 - T8		821282	1
52	1300	8200	7072	2x58 - T8		821382	1
63	1300	11000	8631	2x80 - T5		821482	1
75	1300	12200	9900	1x150 - ME		821582	1

26	690	4100	3562	2x18 - T8	emergency 1h	821180	1
40	690	6440	5400	2x36 - T8		821280	1
52	1300	8200	7072	2x58 - T8		821380	1
63	1300	11000	8631	2x80 - T5		821480	1
75	1300	12200	9900	1x150 - ME		821580	1

26	690	4100	3562	2x18 - T8	emergency 3h	821183	1
40	690	6440	5400	2x36 - T8		821283	1
52	1300	8200	7072	2x58 - T8		821383	1
63	1300	11000	8631	2x80 - T5		821483	1
75	1300	12200	9900	1x150 - ME		821583	1

52	1300	8200	7072	2x58 - T8	DALI	821382DA	1
55	1300	9547	7518	2x80 - T5		821482DA	1
71	1300	11947	9428	1x150 - ME		821582DA	1

Equipment included: pair of eyebolts in AISI 304 stainless steel for pendant mounting, code 820011. Power supply with quick connector. Notes: the stated values may be subject to a +/- 7% tolerance.

EMERGENCY FLUX 1-3h		
Nominal flux (lm) Tj= 25 °C	Output flux (lm) Tq= 25 °C	Emergency output flux (lm) Tq= 25 °C
4100	3562	460
6440	5400	470
8200	7072	460
11000	8631	470
12200	9900	470

AISI 304 stainless steel



Glass

50000h | -30°C +45°C | up to 127 lm/W | UGR < 22 | with 30°x90° lens

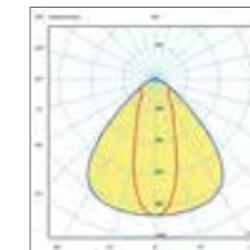

LED light fixture in **stainless steel-glass** with **narrow beam optics 30°x90° IP66**

Device power (W)	Length (mm)	Nominal flux (lm) Tj= 25 °C	Output flux (lm) Tq= 25 °C	Correspondence to traditional lamps (W)	Version	Palazzoli code	Pack Qty
52	1300	8200	6500	2x58 - T8	on-off as standard	820382	1
63	1300	11000	8001	2x80 - T5		820482	1
75	1300	12200	9375	1x150 - ME		820582	1

Equipment included: pair of eyebolts in AISI 304 stainless steel for pendant mounting, code 820011. Power supply with quick connector. Notes: the stated values may be subject to a +/- 7% tolerance.

HT +55°C industrial High temperatures

50000h | -30°C +55°C | up to 142 lm/W | UGR < 22 | with comfort 88° lens

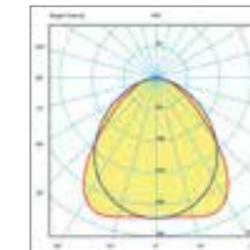

LED light fixture **HT +55°C stainless steel-glass** with **comfort 88° extra wide beam optics IP66**

Device power (W)	Length (mm)	Nominal flux (lm) Tj= 25 °C	Output flux (lm) Tq= 25 °C	Correspondence to traditional lamps (W)	Version	Palazzoli code	Pack Qty
33	1300	5738	4700	2x36 - T8	on-off as standard	821382HT	1
45	1300	7919	6404	2x58 - T8		821482HT	1
54	1300	8830	7600	2x80 - T5		821582HT	1

Equipment included: pair of eyebolts in AISI 304 stainless steel for pendant mounting, code 820011. Power supply with quick connector. Notes: the stated values may be subject to a +/- 7% tolerance.

50000h | -30°C +45°C | up to 137 lm/W | UGR < 22 | with comfort 88° lens

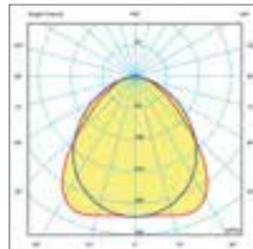

LED light fixture stainless steel-polycarbonate with **comfort 88°** extra wide beam optics IP66

EMERGENCY FLUX 1-3h		
Nominal flux (lm) Tj= 25 °C	Output flux (lm) Tq= 25 °C	Emergency output flux (lm) Tq= 25 °C
8200	7072	460
11000	8631	470
12200	9900	470

Device power (W)	Length (mm)	Nominal flux (lm) Tj= 25 °C	Output flux (lm) Tq= 25 °C	Correspondence to traditional lamps (W)	Version	Palazzoli code	Pack Qty
26	690	4100	3562	2x18 - T8	on-off as standard	826182	1
40	690	6440	5400	2x36 - T8		826282	1
52	1300	8200	7072	2x58 - T8		826382	1
63	1300	11000	8631	2x80 - T5		826482	1
75	1300	12200	9900	1x150 - ME		826582	1
52	1300	8200	7072	2x58 - T8	emergency 1h	826380	1
63	1300	11000	8631	2x80 - T5		826480	1
75	1300	12200	9900	1x150 - ME		826580	1
52	1300	8200	7072	2x58 - T8	emergency 3h	826383	1
63	1300	11000	8631	2x80 - T5		826483	1
75	1300	12200	9900	1x150 - ME		826583	1
52	1300	8200	7072	2x58 - T8	DALI	826382DA	1
55	1300	9547	7518	2x80 - T5		826482DA	1
71	1300	11947	9428	1x150 - ME		826582DA	1

Equipment included: pair of eyebolts in AISI 304 stainless steel for pendant mounting, code 820011. Power supply with quick connector. Notes: the stated values may be subject to a +/- 7% tolerance.

50000h | -30°C +45°C | up to 127 lm/W | UGR < 22 | with 30°x90° lens

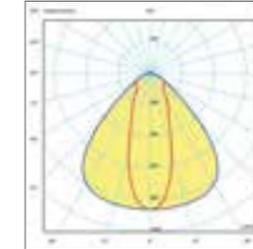

LED light fixture stainless steel-polycarbonate with **narrow beam optics 30°x90°** IP66

Device power (W)	Length (mm)	Nominal flux (lm) Tj= 25 °C	Output flux (lm) Tq= 25 °C	Correspondence to traditional lamps (W)	Version	Palazzoli code	Pack Qty
52	1300	8200	6500	2x58 - T8	on-off as standard	825382	1
63	1300	11000	8001	2x80 - T5		825482	1
75	1300	12200	9375	1x150 - ME		825582	1

Equipment included: pair of eyebolts in AISI 304 stainless steel for pendant mounting, code 820011. Power supply with quick connector. Notes: the stated values may be subject to a +/- 7% tolerance.

HT +55°C industrial High temperatures

50000h | -30 °C +55°C | up to 142 lm/W | UGR < 22 | with comfort 88° lens

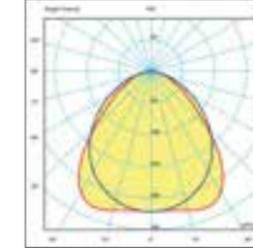

LED light fixture **HT +55°C** stainless steel-polycarbonate with **comfort 88°** extra wide beam optics IP66

Device power (W)	Length (mm)	Nominal flux (lm) Tj= 25 °C	Output flux (lm) Tq= 25 °C	Correspondence to traditional lamps (W)	Version	Palazzoli code	Pack Qty
33	1300	5738	4700	2x36 - T8	on-off as standard	826382HT	1
45	1300	7919	6404	2x58 - T8		826482HT	1
54	1300	8830	7600	2x80 - T5		826582HT	1

Equipment included: pair of eyebolts in AISI 304 stainless steel for pendant mounting, code 820011. Power supply with quick connector. Notes: the stated values may be subject to a +/- 7% tolerance.

Painted galvanized steel



50000h | -30°C +45°C | up to 142 lm/W

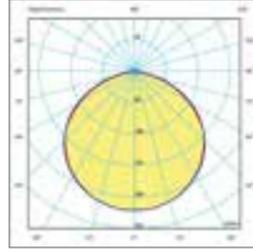

LED light fixture in **Painted galvanized steel glass** with **110° extra wide beam optics** IP66

Device power (W)	Length (mm)	Nominal flux (lm) Tj= 25 °C	Output flux (lm) Tq= 25 °C	Correspondence to traditional lamps (W)	Version	Palazzoli code	Pack Qty
26	690	4100	3692	2x18 - T8	on-off as standard	842182	1
40	690	6440	5640	2x36 - T8		842282	1
52	1300	8200	7384	2x58 - T8		842382	1
63	1300	11000	8946	2x80 - T5		842482	1
75	1300	12200	10575	1x150 - ME		842582	1

Equipment included: pair of eyebolts in AISI 304 stainless steel for pendant mounting, code 820011. Power supply with quick connector. Notes: the stated values may be subject to a +/- 7% tolerance.

50000h | -30°C +45°C | up to 137 lm/W | UGR < 22 | with comfort 88° lens

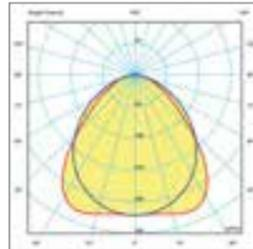

LED light fixture in **Painted galvanized steel glass** with **comfort 88° extra wide beam optics** IP66

Device power (W)	Length (mm)	Nominal flux (lm) Tj= 25 °C	Output flux (lm) Tq= 25 °C	Correspondence to traditional lamps (W)	Version	Palazzoli code	Pack Qty
26	690	4100	3562	2x18 - T8	on-off as standard	841182	1
40	690	6440	5400	2x36 - T8		841282	1
52	1300	8200	7072	2x58 - T8		841382	1
63	1300	11000	8631	2x80 - T5		841482	1
75	1300	12200	9900	1x150 - ME		841582	1

Equipment included: pair of eyebolts in AISI 304 stainless steel for pendant mounting, code 820011. Power supply with quick connector. Notes: the stated values may be subject to a +/- 7% tolerance.

50000h | -30°C +45°C | up to 127 lm/W | UGR < 22 | with 30°x90° lens

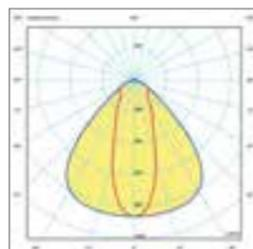

LED light fixture in **Painted galvanized steel glass** with **30°x90° narrow beam optics** IP66

Device power (W)	Length (mm)	Nominal flux (lm) Tj= 25 °C	Output flux (lm) Tq= 25 °C	Correspondence to traditional lamps (W)	Version	Palazzoli code	Pack Qty
52	1300	8200	6500	2x58 - T8	on-off as standard	840382	1
63	1300	11000	8001	2x80 - T5		840482	1
75	1300	12200	9375	1x150 - ME		840582	1

Equipment included: pair of eyebolts in AISI 304 stainless steel for pendant mounting, code 820011. Power supply with quick connector. Notes: the stated values may be subject to a +/- 7% tolerance.

Painted galvanized steel



50000h | -30°C +45°C | up to 137 lm/W | UGR < 22 | with comfort 88° lens

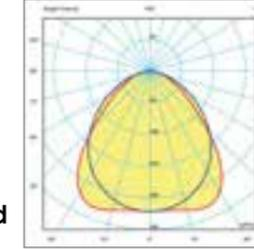

LED light fixture in **Painted galvanized steel polycarbonate** with **comfort 88° extra wide beam optics** IP66

Device power (W)	Length (mm)	Nominal flux (lm) Tj= 25 °C	Output flux (lm) Tq= 25 °C	Correspondence to traditional lamps (W)	Version	Palazzoli code	Pack Qty
26	690	4100	3562	2x18 - T8	on-off as standard	846182	1
40	690	6440	5400	2x36 - T8		846282	1
52	1300	8200	7072	2x58 - T8		846382	1
63	1300	11000	8631	2x80 - T5		846482	1
75	1300	12200	9900	1x150 - ME		846582	1

Equipment included: pair of eyebolts in AISI 304 stainless steel for pendant mounting, code 820011. Power supply with quick connector. Notes: the stated values may be subject to a +/- 7% tolerance.

50000h | -30°C +45°C | up to 127 lm/W | UGR < 22 | with 30°x90° lens

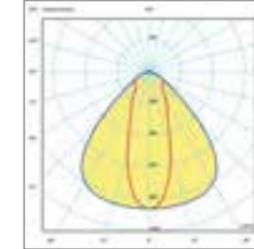

LED light fixture in **Painted galvanized steel polycarbonate** with **30°x90° narrow beam optics** IP66

Device power (W)	Length (mm)	Nominal flux (lm) Tj= 25 °C	Output flux (lm) Tq= 25 °C	Correspondence to traditional lamps (W)	Version	Palazzoli code	Pack Qty
52	1300	8200	6500	2x58 - T8	on-off as standard	845382	1
63	1300	11000	8001	2x80 - T5		845482	1
75	1300	12200	9375	1x150 - ME		845582	1

Equipment included: pair of eyebolts in AISI 304 stainless steel for pendant mounting, code 820011. Power supply with quick connector. Notes: the stated values may be subject to a +/- 7% tolerance.

Accessories

Quick fastening kit for ceiling mounting

Manufacturing material	Light fixture length (mm)	Distance between fixing holes (mm) min. max.	Palazzoli code	Pack Qty
AISI 304 stainless steel	690	300 - 1100	820018	1
	1300	665 - 1440		1

Note: in case of relamping, the quick fastening kit allows to match the fixing distances of the light fixture to those already present in the system.



Pair of adjustable supports for wall or ceiling mounting of steel light fixtures with screw connections

Manufacturing material	Palazzoli code	Pack Qty
AISI 304 stainless steel	820010	1



Pair of "V" brackets for ceiling mounting of steel light fixtures with screw connection

Manufacturing material	Palazzoli code	Pack Qty
AISI 304 stainless steel	820017	1

Example of replacement of a 58W fluorescent light fixture with an LED light fixture code 822382.

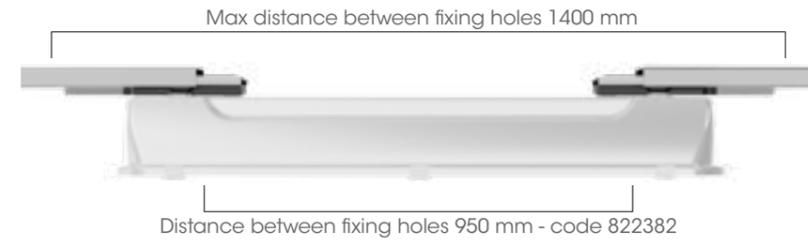

Pair of collars for mounting steel light fixtures on tube with screw connection

Manufacturing material	Palazzoli code	Pack Qty
AISI 304 stainless steel	820016	1



Pair of eyebolts for pendant mounting of steel light fixtures with screw connection

Manufacturing material	Palazzoli code	Pack Qty
AISI 304 stainless steel	820011	1

Retrofit kit



LED reflector with glass diffuser for retrofit

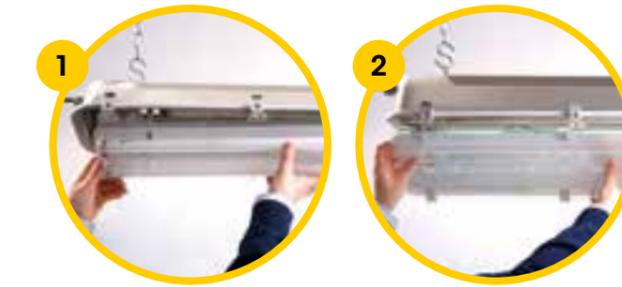

The **retrofit kit** allows you to convert the fluorescent light fixture into a LED light fixture with a simple removal/replacement operation.

Device power (W)	Length (mm)	Nominal flux (lm) Tj= 25 °C	Output flux (lm) Tq= 25 °C	Version	Palazzoli code	Pack Qty
26	690	4100	3562	on-off as standard	821184	1
52	1300	8200	7072		821384	1

Notes: the stated values may be subject to a +/- 7% tolerance.

Dimensions

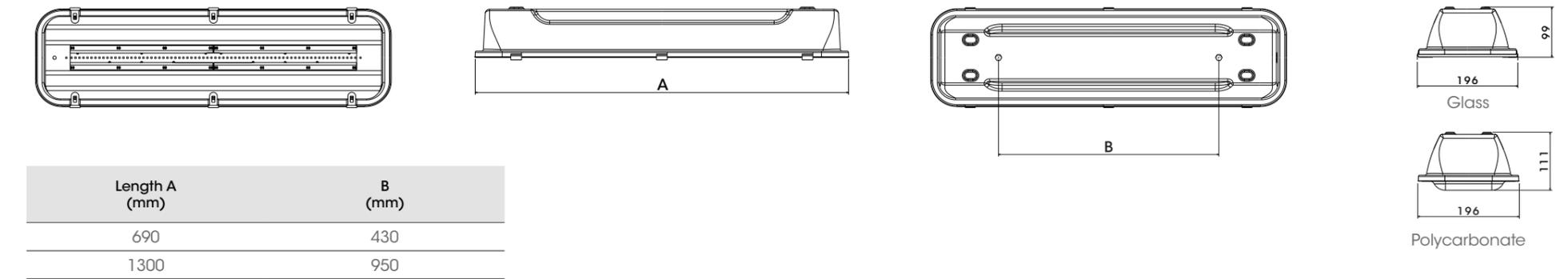

RINO
by Palazzoli

Lighting to save

palazzolilux.com / palazzoli.com

Palazzoli S.p.A. Via F. Palazzoli, 31 - 25128 Brescia - Italy
Tel. +39 030 2015.1 - Fax +39 030 2015.258
export@palazzoli.com

Palazzoli